



SST-CV

POWERED BY



Owners Manual - Convertible Trimmer/Edger

SNAPPER

Attn: CUSTOMER RELATIONS
P.O. BOX 777
McDONOUGH, GA 30253
PHONE: 1-800-935-2967
www.snapper.com

Model	SST-CV Convertible Trimmer/Edger
Shaft style	Straight
Shaft length	62.5"
Engine	34cc 4-cycle Briggs & Stratton
Cutting width	15" - 18"
Line size	.095"/2.4 mm
Unit weight	14.5 lbs
Head type	Bump feed
Starting system	Easy starting 4-cycle
Handle type	Standard loop
Clutch	No
Shoulder harness	Yes
Warranty	2 year Consumer 90 day Commercial



READ THIS MANUAL CAREFULLY BEFORE
PUTTING STRING TRIMMER/EDGER INTO
OPERATION. STRICTLY OBSERVE ALL
SAFETY RULES.

P/N-780061-8/05

This unit is intended for occasional use.

PRINTED IN U.S.A.

TABLE OF CONTENTS

CONTENTS	PAGE
SAFETY RULES	1-2
ASSEMBLY INSTRUCTIONS	2
OPERATION INSTRUCTIONS	3
OPERATION INSTRUCTIONS - EDGER UNIT	4
MAINTENANCE	5
SERVICE/ADJUSTMENTS	6
TROUBLESHOOTING GUIDE	7
STORAGE	7
WARRANTY INFORMATION	8
NOTES	9

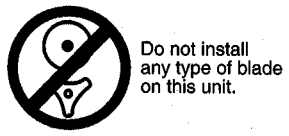

• **WARNING:** Never use blades or flailing devices. This unit is designed for line trimmer use only. Use of any other accessories or attachments will increase the risk of injury.



• **THROWN OBJECTS:** People around the operation of this unit must be warned that debris and objects can be thrown from unit.



• **KEEP FEET AWAY FROM BLADE:** When using the edger attachment always keep cutting unit in front of you. Always move forward away from your body.

RULES FOR SAFE OPERATION

SAFETY AND INTERNATIONAL SYMBOLS

This operator's manual describes safety and international symbols and pictographs that appear on this product. Read the operator's manual for complete safety, assembly, operating, maintenance and repair information.

SYMBOL

MEANING



• **SAFETY ALERT SYMBOL**
Indicates danger, warning or caution. May be used in conjunction with other symbols or pictographs.



• **WARNING - READ OPERATOR'S MANUAL**
Read the operator's manual(s) and follow all warnings and safety instructions. Failure to do so can result in serious injury to the operator and/or bystanders.



• **WEAR EYE AND HEARING PROTECTION**
WARNING: Thrown objects and loud noise can cause severe eye injury and hearing loss. Wear eye protection meeting ANSI Z87.1 standards and ear protection when operating this unit. Use a full face shield when needed.

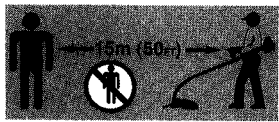

• **KEEP BYSTANDERS AWAY**
WARNING: Keep all bystanders, especially children and pets, at least 50 ft. (15m) from the operating area.



• **THROWN OBJECTS AND ROTATING CUTTER CAN CAUSE SEVERE INJURY**
WARNING: Do not operate without the cutting attachment shield in place. Keep away from the rotating cutting attachment.

SAFETY RULES

- Do not allow a person to use this unit unless instructions are read and understood. Never allow children to operate or play with the unit.
- Do not operate this unit when tired, ill or under the influence of alcohol, drugs, or medication.
- Always wear heavy, long pants, boots, gloves, and a long sleeve shirt. Do not wear loose clothing, jewelry, short pants, sandals, or go barefoot. Secure hair so it is above shoulder level.
- Inspect unit before each use. Replace damaged parts. Check for fuel leaks. Make sure all fasteners are in place and secure. Replace cutting attachment parts that are cracked, chipped, or damaged in any way. Make sure the cutting attachment is properly installed and securely fastened. Be sure the cutting attachment shield is properly attached, and in the position recommended by the manufacturer. Use only flexible, non-metallic line recommended by the manufacturer. Never use, for example, wire or wire-rope which can break off and become a dangerous projectile.
- Keep firm footing and balance. Do not over-reach. Keep cutting attachment below waist level. Keep all parts of your body away from the rotating cutting attachment and hot surfaces.
- Never start or run the unit inside a closed room or building; breathing exhaust fumes can kill.
- Pour fuel outdoors where there are no sparks and flames. Slowly remove the fuel cap only after stopping the engine. Do not smoke while fueling. Wipe spilled fuel from the unit. Move at least 10 ft. (3 m) away from the fueling source and site before starting engine.

SAFETY RULES (CONT.)

- Clear the area to be cut before each use. Remove all objects such as rocks, broken glass, nails, wire, or string which can be thrown or become entangled in the cutting attachment. Clear the area of children, bystanders and pets. At a minimum, keep all children, bystanders and pets outside a 50 ft. (15 m) radius; outside the 50 ft. zone, there is still a risk of injury to bystanders from being struck with the moving strings in the event of a cutting lines thrust or other unexpected reaction of the saw.
- The cutting attachment may be spinning during carburetor adjustments. Wear your protective equipment and observe all safety instructions. When the unit is turned off make sure the cutting attachment has stopped before the unit is set down.
- The handles and shield must be mounted according to the instructions. The unit is designed to be used while positioned on the right side.

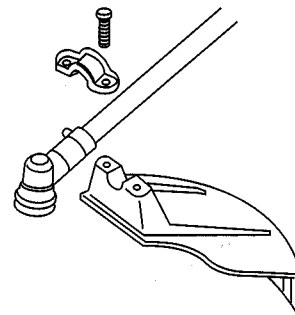

INSTALLING DEBRIS GUARD

- The top clamp is fixed to the tube in the proper position. Attach the debris shield to the clamp with the two screws and hardware provided. Tighten the attaching screws firmly.

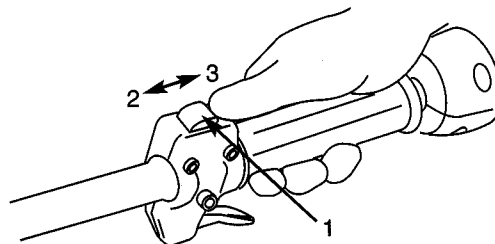

STOP AND START SWITCH

1. Ignition switch
2. Stop
3. Start



SHOULDER HARNESS

- Place the strap over your left shoulder and attach clip to clamp eye on shaft tube.
- Loosen clamp screw and slide clamp up or down until unit balances with head just touching the ground.
- Tighten screw.

ASSEMBLY INSTRUCTIONS

TOOL LIST

- Screwdriver (Phillips or Standard)
- Allen wrench 4 mm

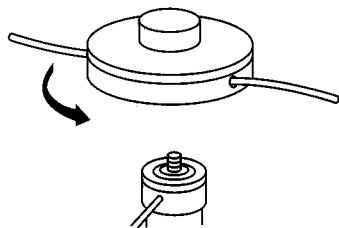

INSTALLING CUTTING HEAD

- Lock gear box by inserting a pin thru hole and finding corresponding notch.
- To install head, turn counterclockwise. Hand-tighten head securely.
- To remove head, turn clockwise.

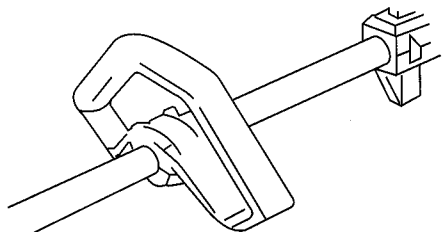

INSTALL ASSIST HANDLE

- Use the 3 screws provided for this assembly. Mount the back edge of the handle clamp to match the arrow on the tube. Adjust the handle for comfort and good balance. Check that the cutting line of the unit is away from your feet and legs.

OPERATING INSTRUCTIONS

HOLDING THE TRIMMER



WARNING: Always wear eye, hearing, foot and body protection to reduce the risk of injury when operating this unit.

Before operating the unit, stand in the operating position (Fig. 1). Check for the following:

- The operator is wearing eye protection and proper clothing.
- With a slightly-bent right arm, the operator's hand is holding the shaft grip.
- The operator's left arm is straight, the left hand holding the D-handle.
- The unit is at waist level.
- The cutting attachment is parallel to the ground and easily contacts the grass without the need to bend over.



Fig. 1

ADJUSTING TRIMMING LINE LENGTH

The bump head cutting attachment allows you to release trimming line without stopping the engine. To release more line, lightly tap the cutting attachment on the ground (Fig. 2) while operating the trimmer at high speed.

NOTE: Always keep the trimming line fully extended. Line release becomes more difficult when the cutting line gets shorter.

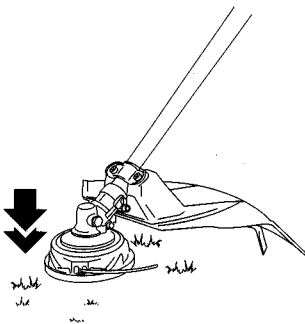

Fig. 2

Each time the head is bumped, about 1 in. (25.4 mm) of trimming line releases. A blade in the cutting attachment shield will cut the line to the proper length if any excess line is released.

For best results, tap the bump knob on bare ground or hard soil. If you attempt a line release in tall grass, the engine may stall. Always keep the trimming line fully extended. Line release becomes more difficult when the cutting line gets shorter.

NOTE: Do not rest the bump head on the ground while the unit is running.

Some line breakage will occur from:

- Entanglement with foreign matter.
- Normal line fatigue.
- Attempting to cut thick, stalky weeds.
- Forcing the line into objects such as walls or fence posts.



CAUTION: Do not remove or alter the line cutting blade assembly. Excessive line length will overload the engine and could cause damage to the engine.

TIPS FOR BEST TRIMMING RESULTS

- Keep the cutting attachment parallel to the ground.
- Do not force the cutting attachment. Allow the tip of the line to do the cutting, especially along walls. Cutting with more than the tip will reduce cutting efficiency and may overload the engine.
- Cut grass over 8 in. (200 mm) by working from top to bottom in small increments to avoid premature line wear or engine drag.
- Cut from right to left whenever possible. Cutting to the left improves the unit's cutting efficiency. Clippings are thrown away from the operator.
- Slowly move the trimmer into and out of the cutting area at the desired height. Move either in a forward-backward or side-to-side motion. Cutting shorter lengths produces the best results.
- Trim only when grass and weeds are dry.
- The life of your cutting line is dependent upon:
 - Following the trimming techniques.
 - What vegetation is being cut.
 - Where vegetation is cut.

For example, the line will wear faster when trimming against foundation wall as opposed to trimming around a tree.

DECORATIVE TRIMMING

Decorative trimming is accomplished by removing all vegetation around trees, posts, fences and more.

Rotate the whole unit so that the cutting attachment is at 30° angle to the ground (Fig. 3).

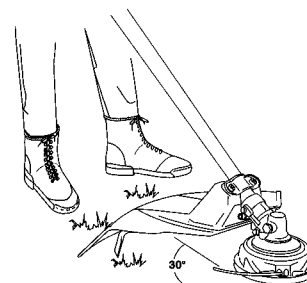



Fig. 3

 **WARNING:** Do not operate this product indoors or inadequately ventilated areas. Engine exhaust contains poisonous emissions and can cause serious injury or death.

USE PROPER CLOTHING AND EQUIPMENT

Before starting the unit, equip yourself and any other person working within the 50 ft. (15 m) Safety Zone with required Protective Equipment and clothing.

KEEP A FIRM GRIP

Hold the front and rear handles with both hands with thumbs and fingers encircling the handles.

KEEP A SOLID STANCE

Maintain footing and balance at all times. Do not stand on slippery, uneven or unstable surfaces. Do not work in odd positions or on ladders. Do not over reach.

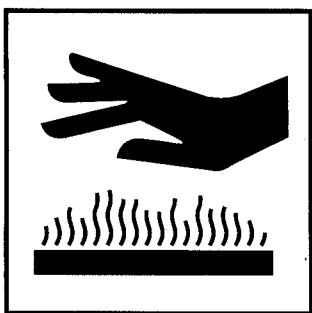

AVOID HOT SURFACES

During operation, the exhaust area may become very hot, too hot to touch. Avoid contact during and immediately after operation. Always keep exhaust area clear of flammable debris. Allow the engine and muffler to completely cool before any maintenance activity.

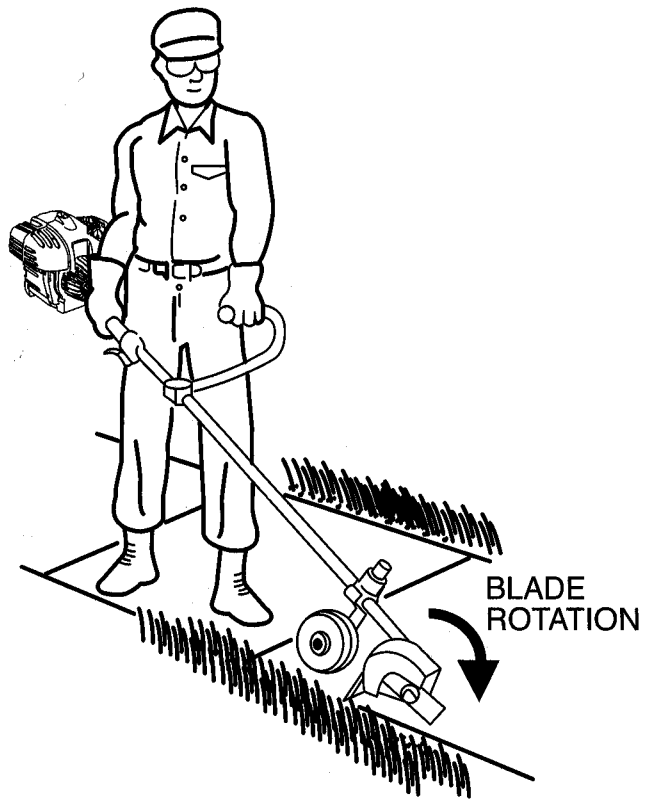

MAINTENANCE

Refer to your **BRIGGS & STRATTON owners' manual** for engine information

- | | |
|-----------------------------|---------------------------|
| 1. Adding Oil to a New Unit | 5. Starting a Warm Engine |
| 2. Adding Fuel | 6. Engine Maintenance |
| 3. Starting a NEW Engine | 7. Engine Adjustments |
| 4. Starting and Stopping | 8. Service and Storage |
| | 9. Engine Warranty |

Periodic Maintenance Chart



WARNING:

Accidental engine starting can cause injury. Always remove the spark plug before servicing the engine to prevent accidental starting.

LACK OF MAINTENANCE OR IMPROPER MAINTENANCE CAN RESULT IN INJURY. MODIFYING PARTS IN ANY MANNER OR REMOVING ANY PART OF THIS UNIT CAN RESULT IN INJURY. USE OF NON-CONFORMING PARTS OR COMPONENTS CAN RESULT IN INJURY.

MAINTENANCE	EACH USE	AFTER EVERY SEASON OR		
		FIRST 10 HOURS	EVERY 25 HOURS	EVERY 50 HOURS
Change oil*			●*	
Check and replenish fuel	●			
Check and replenish oil	●			
Check bolts, nuts and screws for looseness and loss	●			
Check throttle lever operation	●			
Check engine switch operation	●			
Check guard assembly condition	●			
Clean/replace in-tank fuel filter				●
Clean air filter element		●		
Tighten bolts, nuts and screws		●		●
Clean spark plug and adjust electrode gap				●
Remove dust and dirt from cylinder fins				●
Remove carbon deposits in the exhaust muffler				●
Clean spark arrester screen				●
Check gear case assembly lubrication				●
Check drive shaft lubrication				●
Check valve clearance				●

*Change engine oil after first 4 hours of use. Please refer to the engine manual for more details.

NOTE:

The service intervals indicated are to be used as a guide. Service to be performed more frequently as necessary by operating condition. These items must be performed with proper tools. See your authorized dealer for service.

LINE REPLACEMENT

SAFETY RULES

1. Shut down the trimmer to make certain the head cannot turn while working with the head.
2. Check mounting of cutting head on trimmer and tighten if it is loose.
3. Inspect head for wear, chips or cracks. Replace parts or entire head if needed.
4. Always use line that is the correct diameter and type for this unit. Do not use metal reinforced or metal line.
5. Make sure the two retaining pawls spread out to the periphery of the cover windows.
6. Check the head for deflection or abnormal noise by rotating the head by hand. Deflection or abnormal noise may cause vibrations, which will cause the cutting line to weld together. It is also potentially dangerous.

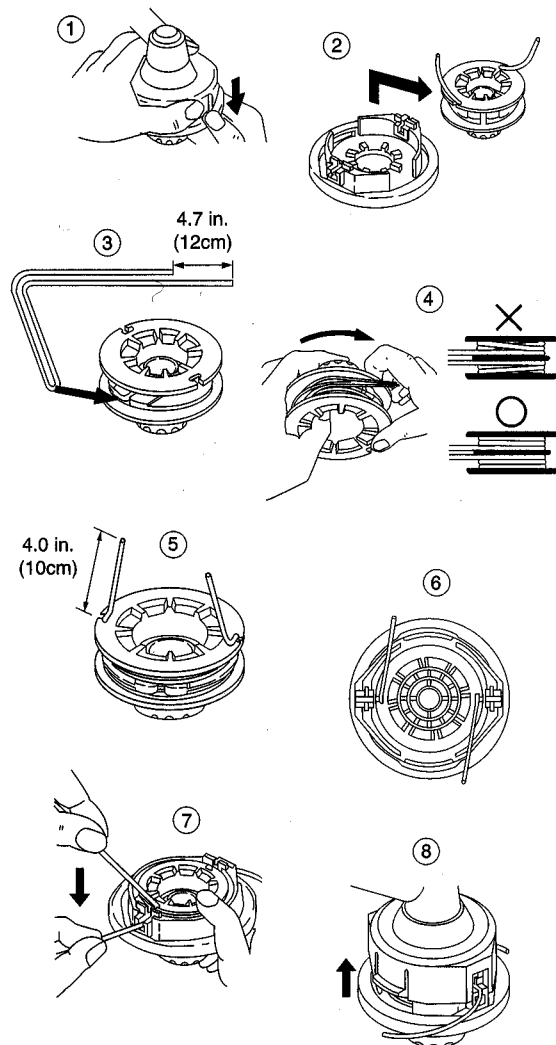

REFILLING TRIMMING LINE

1. For replacement line, use a diameter of .095 in. (2.4 mm). The spool is capable for a line up to 20 ft. (6 m) on the 4 in. head. Avoid using a larger line as it may cut down the trimming performance.
2. Pinch the slotted area on the both sides of the spool housing to unhook the bottom cap.
3. Take out the spool and pull off the old line. Put one end of new line through the spool holes and pull it until the length is equal between each part of the line.
4. Wind up the line in the correct direction as indicated on the spool.
5. Hook each end of the line in the slot on the edge of the spool, and then put the ends through the eyelets on the housing. Make sure that the spring and the washers are in place.
6. While holding the spool against the housing, pull the line ends to release them from the slot.
7. Line up the slot on the bottom cap with the hook on the housing, press the cap against the housing until it clicks.

TROUBLESHOOTING GUIDE

Case 1. Starting failure

CHECK		PROBABLE CAUSES		ACTION
Fuel tank	→	Incorrect fuel	→	Drain it and fill with correct fuel
Fuel filter	→	Fuel filter is clogged	→	Clean
Carburetor idle speed screw	→	Out of normal range	→	Adjust to normal range
No spark	→	Spark plug is fouled/wet	→	Clean/dry
	→	Plug gap is incorrect	→	[Correct GAP .025" (0.6-0.7 mm)]
Spark plug	→	Disconnected	→	Retighten

Case 2. Engine starts but does not keep running/Hard re-starting

CHECK		PROBABLE CAUSES		ACTION
Fuel tank	→	Incorrect fuel or stale fuel	→	Drain it and fill with correct fuel
Carburetor idle speed screw	→	Out of normal range	→	Adjust to normal range
Muffler, cylinder(exhaust port)	→	Carbon is built-up	→	Wipe away
Air cleaner	→	Clogged with dust	→	Wash
Cylinder fin, fan cover	→	Clogged with dust	→	Clean

If your unit needs further service, please consult with an authorized service dealer in your area.

STORAGE



WARNING: Perform the following steps after each use:

- Allow engine to cool, and secure the unit before storing or transporting.
- Store unit and fuel in a well ventilated area where fuel vapors cannot reach sparks or open flames from water heaters, electric motors or switches, furnaces, etc.
- Store unit with all guards in place. Position unit so that any sharp objects cannot accidentally cause injury.
- Store unit and fuel well out of the reach of children.

SEASONAL STORAGE

Prepare unit for storage at end of season or if it will not be used for 30 days or more. If your unit is to be stored for a period of time:

- Drain all fuel from the fuel tank into the proper receptacles for storage.
- Press purge bulb 15 times to remove all fuel from carburetor and fuel lines. Drain this fuel into proper receptacles. If fuel is to be disposed, please refer to local rules for proper disposal.
- Clean the entire unit before lengthy storage.
- Store in a clean dry area.
- Lightly oil external metal surfaces.
- This trimmer may be stored in a variety of positions. If possible, it is preferred to store the trimmer in a horizontal position with the spark plug up. The trimmer should not be stored or transported with the spark plug down.
- Storing or transporting the trimmer with the spark plug down may result in white smoke coming from the muffler or difficulty starting.

FUEL SYSTEM

Fuel stabilizer is an acceptable alternative in minimizing the formation of fuel gum deposits during storage. Add stabilizer to the gasoline in the fuel tank or fuel storage container. Follow the mix instructions found on stabilizer container. Run engine at least 5 minutes after adding stabilizer.

ENGINE

- Remove spark plug and pour 1 teaspoon of HD30 wt. engine oil through the spark plug opening. Slowly pull the starter rope 8 to 10 times to distribute oil.
- Replace spark plug with new one of recommended type and heat range.
- Clean air filter.
- Check entire unit for loose screws, nuts, and bolts. Replace any damaged, broken, or worn parts.
- At the beginning of the next season, use only fresh fuel.

OTHER

- Do not store gasoline from one season to another.
- Replace your gasoline can if it starts to rust.
- When removing the unit from storage, only use fresh gasoline. Perform the routine operation checks as spelled out in the manual before any start.

WARRANTY

SNAPPER hereby warrants to the original retail purchaser ALL NEW products of its own manufacture to be free from defect in material and workmanship, for a period of two (2) years from the date of the original purchase, subject to the following exceptions.

Products	Consumer Use	Commercial/Rental Use
Hand Held String Trimmers/Edgers	2 Years	90 Days

- **No warranty is extended to any equipment, which has been misused, neglected, or damaged by accident. Snapper shall not be responsible for damage in transit or handling by any common carrier. Under no circumstances, within or without the warranty period, will the company be liable for damage for loss, or damage resulting from delay, or any consequential damage including but not limited to any cost or expense of providing substitute equipment or service during periods of malfunction or non-use. snapper will repair or replace, free of charge any part or parts of the units found upon examination by any Factory Authorized Dealer or by the factory to be defective in materials and or workmanship for the term of the warranty.**
- **The consumer is responsible for: (1) normal maintenance such as greasing, gear case lubrication, minor adjustment and (2) transportation of any Snapper product to and from the place warranty work is performed.**
- **Snapper warranty WILL NOT APPLY to any products repaired or altered by anyone other than an Authorized Service Distributor or Authorized Service Dealer.**
- **Snapper reserves the right to incorporate any changes in design into its products without obligation to make changes on units previously manufactured.**
- **For engine warranty, please refer to the Briggs & Stratton manual.**



SNAPPER
Attn: CUSTOMER RELATIONS
P.O. BOX 777
McDONOUGH, GA 30253
PHONE: 1-800-935-2967
www.snapper.com